

HEXAGRID

What do you get?

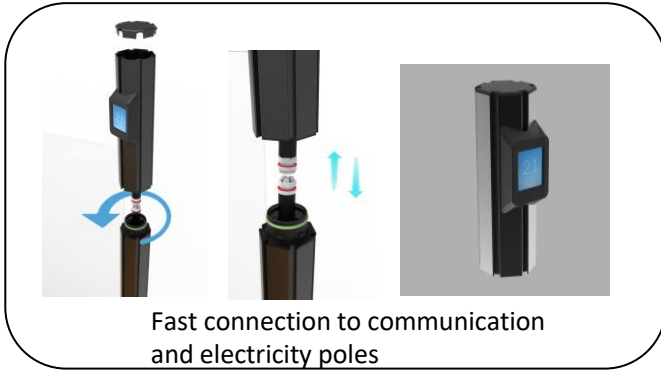

Fast connection to communication and electricity poles

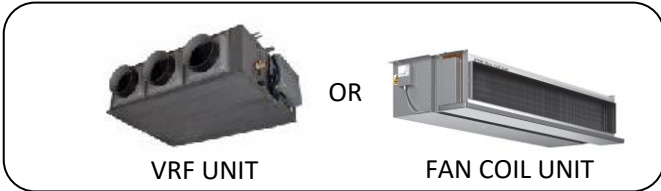

VRF UNIT

FAN COIL UNIT

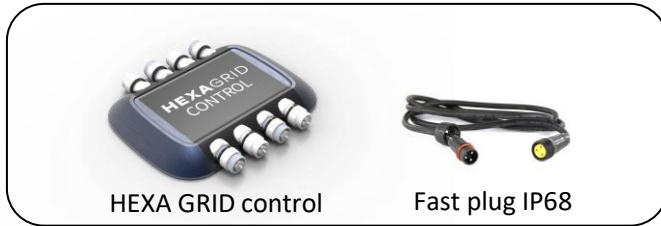

HEXA GRID control

Fast plug IP68

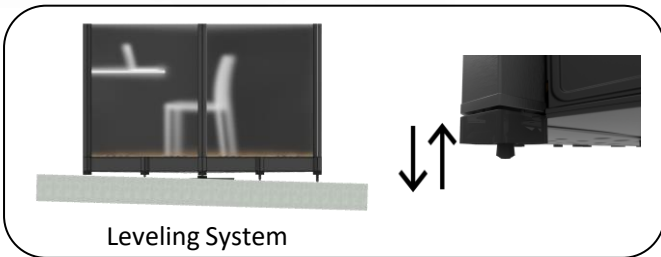

Leveling System



Water level sensor

Water pump

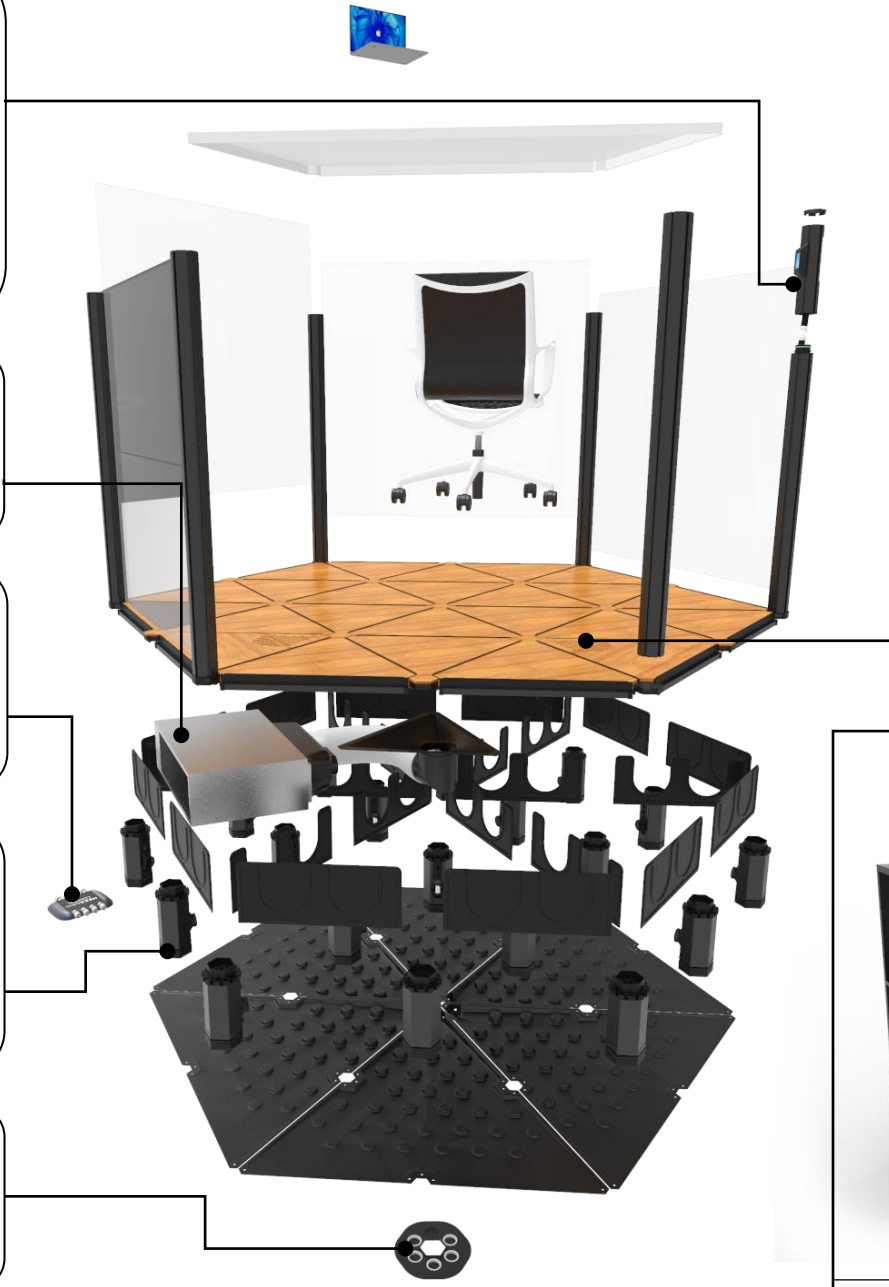

Personal AC Air Diffuser outlets

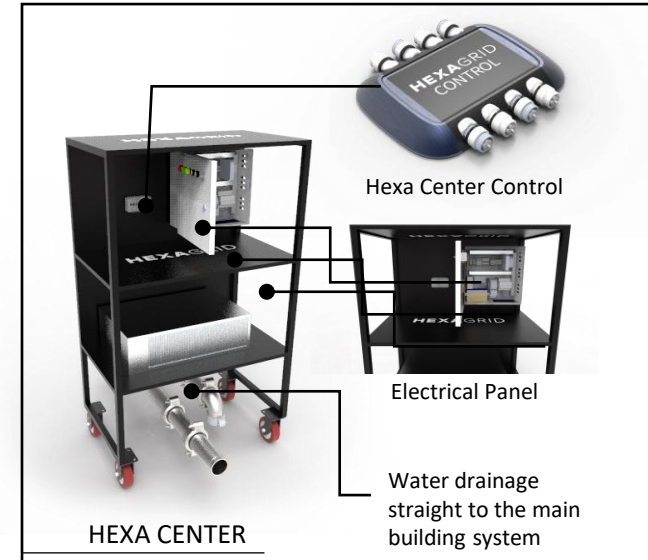

Hexa Center Control

Electrical Panel

Water drainage straight to the main building system

HEXA CENTER

HEXA Stands
up to 26 units

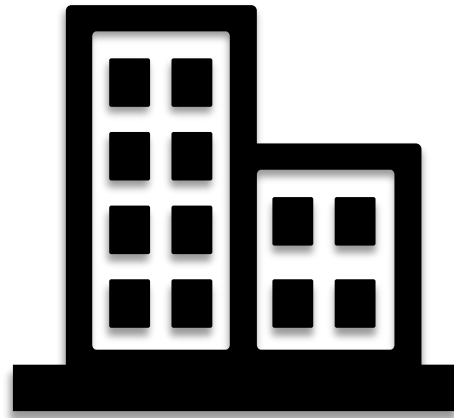
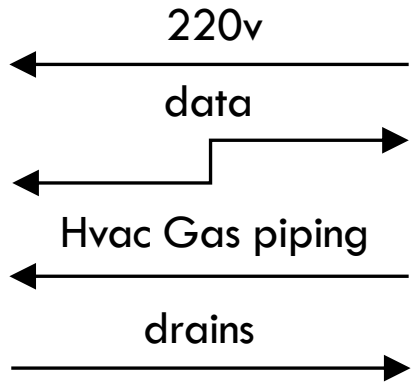
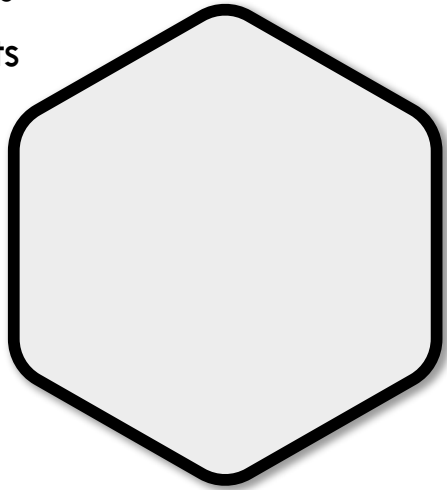

BUILDING CORE

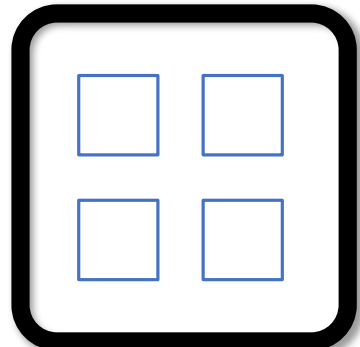

Hexa Center Panel

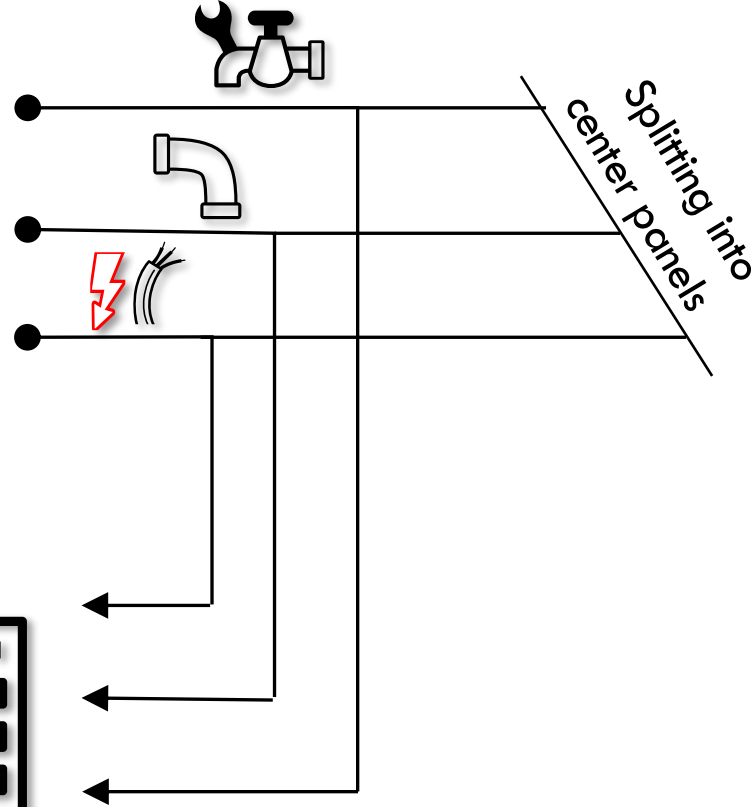
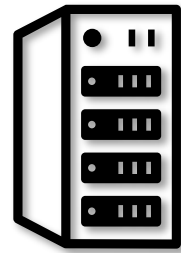

Hexa Pole
Ports for communication
and voltage connections

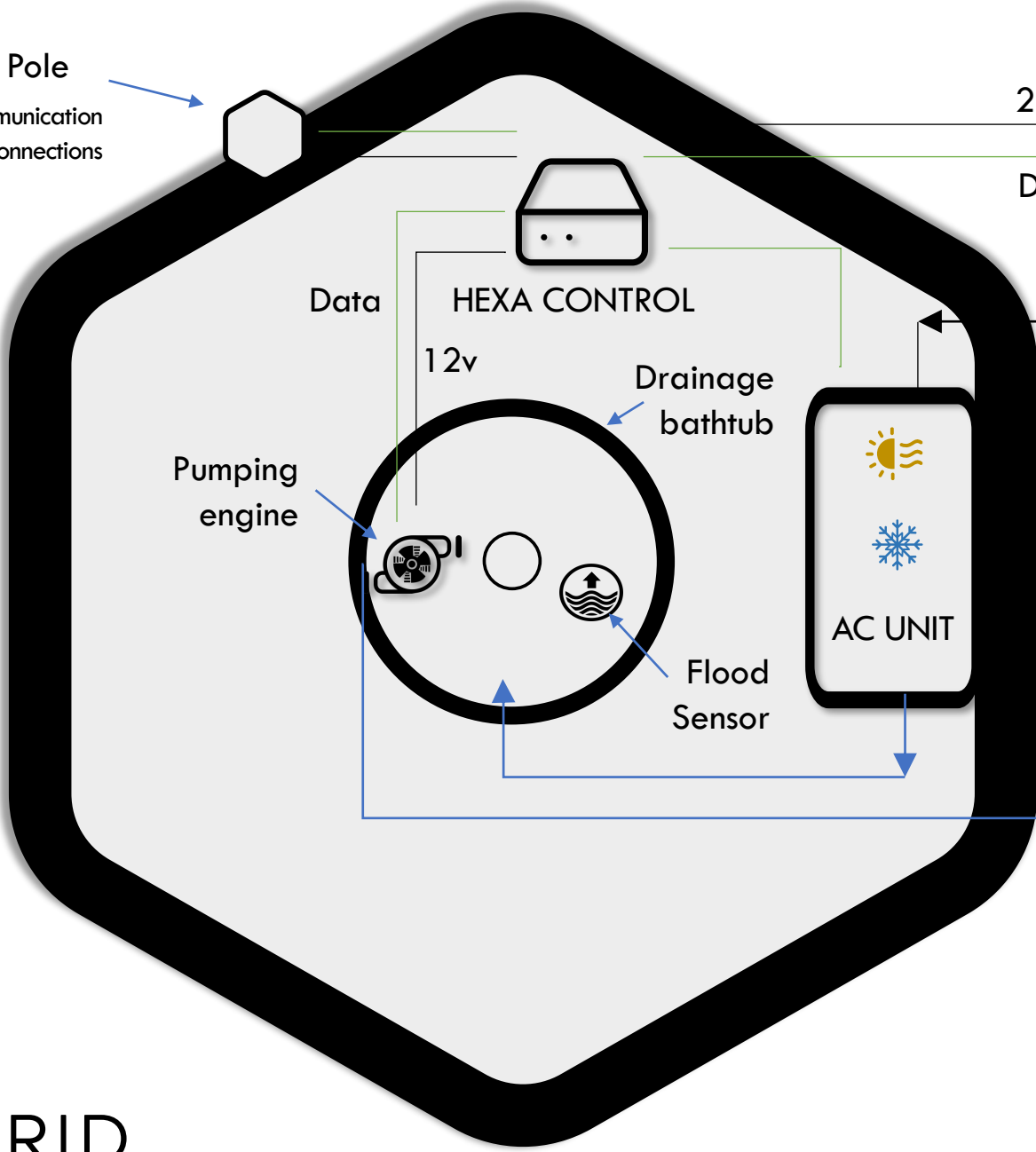

220v

Data

Data

HEXA CONTROL

12v

Drainage
bathtub

Pumping
engine

Flood
Sensor

AC UNIT

220v

data

HVAC Gas Piping

drains

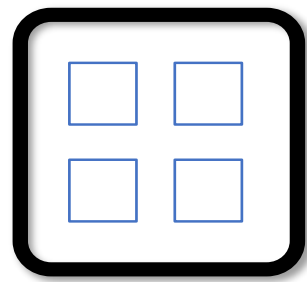

Hexa Center
Panel

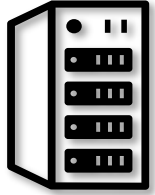

HEXA Stands
up to 26 units



HEXAGRID
SHAPE YOUR SPACE

Hexa below surface Stand Flowchart

